



Quick Start Guide



Safety Instructions

Safety Instructions (UK)

To prevent damage to your Datapath product or injury to personnel operating the equipment, please read the following safety precautions prior to operation. These instructions should be made available to all those who will use and operate Datapath products.

Power Supply

All Datapath products require a mains power supply. This power supply must be disconnected when equipment is being upgraded or relocated.

Cables

Do not expose cables to any liquids, doing so may cause a short circuit which could damage the equipment. Do not place heavy objects on top of any cables as this can cause damage and possibly lead to exposed live wires.

Ventilation

All computer equipment should be located in a well ventilated area. All ventilation holes on the computer casing must be kept clear of any obstruction at all times. Failure to do so will result in the system over heating and damaging your equipment.

Working Environment

The equipment should be located in an environment free from dust, moisture and extreme changes in temperature and should be placed on a stable and solid work surface. Liquids (hot/cold drinks etc) should not be placed near the equipment as spillage could cause serious damage.

Gas/Flammable Liquids

Electronic equipment should never be used in the presence of gas or any flammable liquid, doing so could result in an explosion or serious fire.

Smoke/Unusual Smells

Should you notice smoke or unusual smells being emitted from your computer, turn off and unplug the system from the mains supply. The system should then be passed to a qualified technician for inspection. Continued operation could result in personal injury and damage to property.

Maintenance

Maintenance should only be carried out by competent technicians, any Datapath plug-in cards that are physically damaged should be returned to Datapath for repair using Datapath RMA procedures.

Disposal

At the end of life all Datapath products should be disposed of as per local laws and regulations dictate. In UK contact Datapath to arrange disposal. Our WEE registration number is WEEE/AA0005ZR.

Rack Mount Safety Instructions

Temperature

If the Datapath dL8 is to be installed in a closed or multi-unit rack assembly, the installation should be such that the amount of air flow required for safe operation of the equipment is not compromised. The operating ambient temperature of the rack environment should be maintained below 35 degrees centigrade under all conditions. Appropriate cooling arrangements should be built into the cabinet to ensure that this specification is maintained.

Mechanical Loading

Mounting of the equipment in the rack should be such that a hazardous condition is not achieved due to uneven mechanical loading.

Circuit Overloading

Consideration should be given to the connection of the equipment to the mains supply circuit and the effect that overloading of the supply might have on any overcurrent protection or supply wiring. Appropriate consideration of equipment nameplate ratings should be used when addressing this concern.

Reliable Earthing

Reliable earthing of all rack-mounted equipment should be maintained. Particular attention should be given to supply connections other than direct connections to the branch circuit (e.g. use of power strips).

Consignes de sécurité (Fr)

Afin de ne pas endommager votre produit Datapath et d'éviter tout risque de blessure du personnel exploitant le matériel, veuillez lire les consignes de sécurité suivantes avant toute utilisation. Ces instructions doivent être mises à disposition de toute personne souhaitant utiliser et exploiter les produits Datapath.

Alimentation électrique

Tous les produits Datapath requièrent une alimentation électrique principale. Cette alimentation électrique doit être interrompue en cas de mise à jour ou de relocalisation du matériel.

Câbles

Ne pas exposer les câbles à un liquide quelconque car cela pourrait provoquer un court-circuit susceptible d'endommager le matériel.

Ne pas placer d'objets lourds sur les câbles car cela pourrait causer des dommages et conduire éventuellement à des fils électriques dénudés.

Ventilation

Tout matériel informatique doit être disposé dans un endroit bien ventilé. Veiller à ne jamais obstruer les orifices de ventilation du boîtier de l'ordinateur ; sinon, il y a risque de surchauffe du système et votre matériel peut être endommagé.

Environnement de travail

Le matériel doit être placé sur une surface de travail stable et solide, dans un environnement exempt de poussière et d'humidité et non exposé à des variations extrêmes de températures. Ne pas placer de liquides (boissons chaudes/froides, etc.) près du matériel, car un déversement accidentel pourrait causer de graves dommages.

Gaz/Liquides inflammables

Le matériel électronique ne doit jamais être utilisé en présence de gaz ou de liquide inflammable ; cela pourrait entraîner une explosion ou un grave incendie.

Fumée/odeurs inhabituelles

Si vous constatez la présence de fumée ou d'odeurs inhabituelles émanant de votre ordinateur, éteignez-le et débranchez le système de l'alimentation secteur. Dans ce cas, le système devra être confié à un technicien qualifié pour inspection. Une poursuite de son utilisation risquerait de provoquer des blessures corporelles et des dommages matériels.

Entretien

L'entretien doit impérativement être effectué par des techniciens compétents, toute carte enfichable Datapath physiquement endommagée est à retourner à Datapath pour réparation via la procédure Datapath RMA.

Élimination

En fin de vie, tous les produits Datapath seront éliminés conformément aux législations et réglementations locales. Au Royaume-Uni, veuillez contacter Datapath pour organiser l'élimination. Notre numéro d'enregistrement de Déchets d'équipements électriques et électroniques : WEEE/AA0005ZR.

Consignes de sécurité du montage sur bâti

Température

S'il est prévu d'installer les systèmes dL8 dans une enceinte fermée ou dans un bâti comportant plusieurs unités, l'installation devra être effectuée de telle manière que le débit d'air requis pour la sûreté de fonctionnement du matériel ne soit pas compromis. La température ambiante de fonctionnement de l'environnement du bâti doit être maintenue en-dessous de 35 degrés centigrades dans toutes les conditions. Des dispositifs de refroidissement appropriés doivent être intégrés dans l'armoire de façon à garantir le maintien de cette spécification.

Charge mécanique

Le montage du matériel doit être effectué de manière à exclure toute situation dangereuse pouvant provenir d'une charge mécanique irrégulière.

Surcharge du circuit

Il convient d'apporter une certaine importance au raccordement du matériel au circuit de l'alimentation secteur et aux effets qu'une surcharge de l'alimentation pourrait avoir sur une protection contre les surintensités ou les câbles d'alimentation. Vérifiez pour cela les valeurs nominales sur les plaques d'identification du matériel.

Fiabilité de la mise à la terre

Veiller à une mise à la terre fiable de tout matériel monté sur bâti. Une attention particulière devra être accordée aux raccordements d'alimentation autres que les raccordements directs au circuit de dérivation (utilisation de multiprises par exemple).

Instrucciones de seguridad (Esp)

Rogamos leer las siguientes instrucciones de seguridad antes de poner en funcionamiento el equipo, a fin de evitar daños en su producto de Datapath o lesiones al personal encargado de su manejo. Poner estas instrucciones a disposición de todos aquellos que vayan a utilizar y/o manejar los productos de Datapath.

Alimentación eléctrica

Todos los productos de Datapath requieren una fuente de alimentación eléctrica. Esta fuente de alimentación eléctrica debe ser desconectada durante las tareas de renovación o traslado.

Cables

No exponer los cables a líquidos, ya que ello puede causar un cortocircuito y, por consiguiente, daños en el equipo. No colocar objetos pesados sobre los cables, ya que esto puede ocasionar daños y poner al descubierto los cables vivos.

Ventilación

Todos los equipos informáticos deben estar situados en un área bien ventilada. Mantener todos los orificios de ventilación de la carcasa del ordenador siempre libres de obstrucciones de cualquier tipo. En caso contrario, podría producirse un sobrecalentamiento del sistema y daños en el equipo.

Entorno de trabajo

El equipo debe estar emplazado en un ambiente sin polvo, humedad ni cambios bruscos de temperatura y debe ser situado sobre una superficie estable y sólida. No colocar líquidos (bebidas calientes/frías, etc.) cerca del equipo, ya que un derrame podría causar graves daños.

Gas/líquidos inflamables

El equipo electrónico nunca debe ser usado en presencia de gas o líquido inflamable, ya que esto podría causar una explosión o un incendio grave.

Humo/olores inusuales

En caso de percibir humo u olores inusuales provenientes de su ordenador, apagar y desenchufar el equipo de la red eléctrica. El sistema debe ser confiado entonces a un técnico cualificado para su

inspección. Si el equipo continuara funcionando, esto podría ocasionar lesiones personales y daños materiales.

Mantenimiento

El mantenimiento solo debe ser ejecutado por técnicos capacitados. Las tarjetas insertables (plug-in) de Datapath que estén físicamente dañadas deben ser devueltas a Datapath para su reparación según los procedimientos RMA (Return Merchandise Agreement) de Datapath.

Eliminación

Al final de su vida útil, todos los productos de Datapath deben ser eliminados de acuerdo con las leyes y normativas locales. En el Reino Unido, contactar a Datapath para organizar la eliminación. Nuestro número de registro WEE (Waste Electrical and Electronic Equipment) es WEEE/AA0005ZR.

Instrucciones de seguridad para montaje en bastidor

Temperatura

Si los sistemas dL8 se montan en un bastidor cerrado o en un bastidor de varias unidades, la instalación se deberá realizar evitando que afecte al flujo de aire necesario para un funcionamiento seguro. Mantener la temperatura ambiente del entorno del bastidor por debajo de los 35 grados centígrados bajo todo tipo de condiciones. Instalar en el armario los dispositivos adecuados de refrigeración a fin de asegurar que se cumple esta especificación.

Carga mecánica

Efectuar el montaje del equipo en el bastidor de tal modo que se eviten situaciones de peligro debidas a una carga mecánica irregular.

Sobrecarga del circuito

Tener especial cuidado al realizar la conexión del equipo al circuito de la red eléctrica a fin de evitar que una sobrecarga de ésta pueda afectar a algún dispositivo de protección contra corriente de sobreintensidad o al cableado de alimentación. Tener en cuenta las capacidades especificadas en la placa indicadora del equipo al conectarlo a la red.

Puesta a tierra segura

Asegurar la puesta a tierra segura de todos los equipos montados en bastidor. Prestar especial atención a las conexiones de alimentación que no sean conexiones directas al circuito en derivación (por ejemplo, mediante regletas).

Sicherheitsanweisungen (D)

Die folgenden Sicherheitsanweisungen dienen der Vermeidung von Schäden an Ihrem Datapath-Produkt und Verletzungen der Nutzer. Bitte lesen Sie sie sorgfältig durch, bevor Sie Ihr Produkt in Betrieb nehmen. Diese Anweisungen sollten allen Personen zugänglich gemacht werden, die mit der Nutzung und der Bedienung von Datapath-Produkten betraut sind.

Stromversorgung

Alle Datapath-Produkte müssen an die Hauptstromversorgung angeschlossen werden. Die Stromversorgung muss unterbrochen werden, wenn Geräte ausgetauscht oder an einer anderen Stelle platziert werden sollen.

Kabel

Kabel dürfen nicht mit Flüssigkeiten in Berührung kommen, da dadurch ein Kurzschluss und somit ein Schaden an dem Gerät ausgelöst werden könnte. Stellen Sie außerdem keine schweren Objekte auf die Kabel, um Schäden und offen liegende stromführende Leitungen zu vermeiden.

Lüftung

Computerausrüstung sollte in einem gut gelüfteten Bereich aufgestellt werden. Die Lüftungslöcher am Computergehäuse müssen stets freigehalten werden, um eine Überhitzung und somit einen Geräteschaden zu vermeiden.

Arbeitsumgebung

Die Geräte sollten in einer staubfreien und trockenen Umgebung, in der keine extremen Temperaturänderungen zu erwarten sind, auf einer stabilen Arbeitsfläche aufgestellt werden. In der Nähe der Geräte sollten keine Flüssigkeiten (heiße/kalte Getränke etc.) platziert werden, die versprüht werden und schwerwiegende Schäden anrichten könnten.

Gas/brennbare Flüssigkeiten

Elektronische Geräte sind nicht in Umgebungen zu verwenden, in denen Gas oder brennbare Flüssigkeiten vorhanden ist/sind und somit Brand- und Explosionsgefahr besteht.

Rauch/ungewöhnliche Gerüche

Schalten Sie das System aus und trennen Sie es von der Hauptversorgung, wenn von Ihrem Computer Rauch ausgeht oder dieser ungewöhnliche Gerüche abgibt. Lassen Sie das System anschließend von einem qualifizierten Techniker prüfen. Bei fortgeführtem Betrieb besteht die Gefahr von Verletzungen und Sachschäden.

Wartung

Wartungsarbeiten sollten nur von qualifizierten Technikern durchgeführt werden. Physisch beschädigte Plug-in-Karten von Datapath sollten zur Reparatur unter Einsatz der RMA-Verfahren von Datapath an Datapath übergeben werden.

Entsorgung

Am Ende ihrer Nutzungsdauer sollten Datapath-Produkte gemäß den lokalen Gesetzen und Bestimmungen entsorgt werden. Für Nutzer in Großbritannien: Bitte kontaktieren Sie Datapath, um Vorkehrungen zur Entsorgung von Datapath-Produkten zu treffen. Unsere WEE-Registrierungsnummer lautet WEEE/AA0005ZR.

Sicherheitsanweisungen zur Rack-Montage

Temperatur

Um einen sicheren Betrieb zu gewährleisten, muss ausreichend Luft zur Kühlung sichergestellt werden, wenn dL8-Systeme in einem geschlossenen Rack-Aufbau oder einem Aufbau für mehrere Geräte installiert werden. Die Umgebungstemperatur in dem Bereich, in dem sich das Rack befindet, sollte stets unterhalb von 35° C liegen. Das Gehäuse sollte mit einer Vorrichtung zur angemessenen Kühlung ausgestattet sein, sodass diese Spezifikation erfüllt werden kann.

Mechanische Belastung

Um Gefahrensituationen zu vermeiden, muss bei der Platzierung der Geräte in das Rack auf eine gleichmäßige mechanische Belastung geachtet werden.

Schaltkreisüberlastung

Beim Anschluss der Geräte an die Hauptstromversorgung sollten die Auswirkungen berücksichtigt werden, die eine Überlastung der Stromversorgung auf einen eventuell vorhandenen Überstromschutz oder Versorgungsleitungen haben könnte. In diesem Zusammenhang sind die Typenschilder der Geräte zu beachten.

Zuverlässige Erdung

In Bezug auf in Racks montierte Geräte ist stets auf eine zuverlässige Erdung und insbesondere auf Versorgungsleitungen zu achten, die nicht direkt an den jeweiligen Stromkreis angeschlossen sind (Nutzung von Steckerleisten etc.).

Datapath dL8

Congratulations on your purchase. The Datapath dL8 is an eight output distribution amplifier for ultra-high resolution Dual-Link DVI signals.

One Dual-Link DVI input, supporting graphics sources with pixel clocks up to 330MHz and resolutions beyond quad-HD (3840x2160 @ 30 Hz), can be delivered to up to eight outputs on separate DVI-D (Dual Link) connectors.

This Quick Start Guide is designed to aid quick installation and set up of your new dL8, however should you experience any problems not covered in this guide please refer to your supplier.

Step 1

Packing List – Your box should contain:

- dL8 - Distribution amplifier
- USB Cable
- Power Cable
- Quick Start Guide
- Software CD

Step 2

Unpacking

Inspect items for damage. Should any items show any signs of damage, report it immediately to your supplier.

Retain packaging materials for future shipping requirements.

Front View

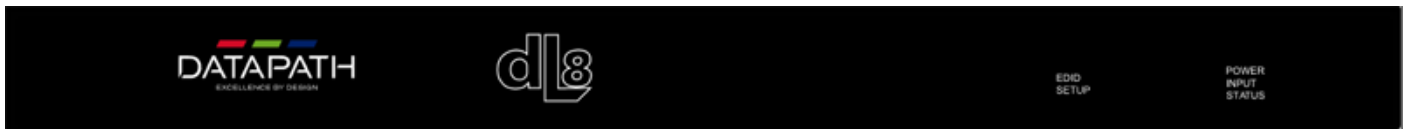

Fig.1

Rear View

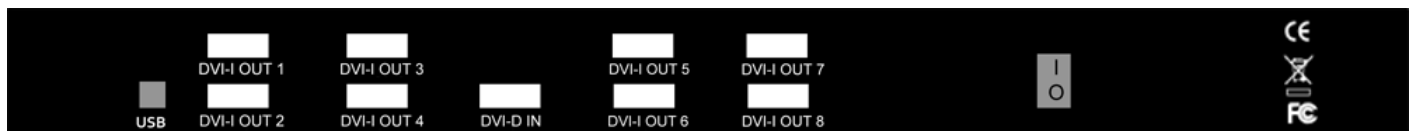

Fig.2

Top View

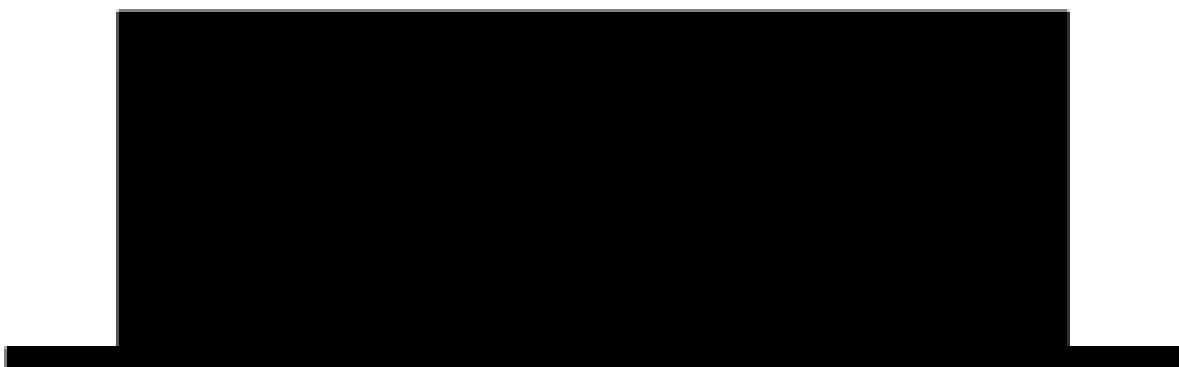

Fig.3

Step 3

Getting Started

- Ensure the power supply for the DVI source is disconnected.
- Connect the cable from the DVI source to the input socket on the rear of the dL8.
- Connect up to eight displays/Datapath x4s to the output sockets on the rear panel of the dL8.
- Connect the power cable to the dL8 and switch on the power supply.
- Power up the DVI source.

The Power LED located on the front panel will illuminate to indicate that power has successfully been applied to the unit.

The dL8 incorporates an internal processor that will continuously monitor the received DVI signal, and whenever a valid and stable input is detected the Input LED is illuminated.

How to Connect the Input

Connect the output cable of the DVI source to the Dual Link DVI input connector on the dL8.

You should exercise great care when connecting all cables to the connectors on your dL8.

If the pins are oriented correctly and the connector is pushed on squarely, the use of force is not required. Poor handling may cause some pins to bend within the plug on the cable and this, in turn will cause damage to the output socket and in some instances will cause irreparable damage to the Printed Circuit Board located inside the unit. Such damage is not covered under warranty

How to Connect the Outputs

The Datapath dL8 has eight DVI-I (Dual Link) connectors, each connector can be linked to separate Datapath x4 units using cables up to 20m in length. This is due to the built in equalization in the x4. Cable lengths of up to 5m in length can be used in all other instances where the output devices do not have built in equalization.

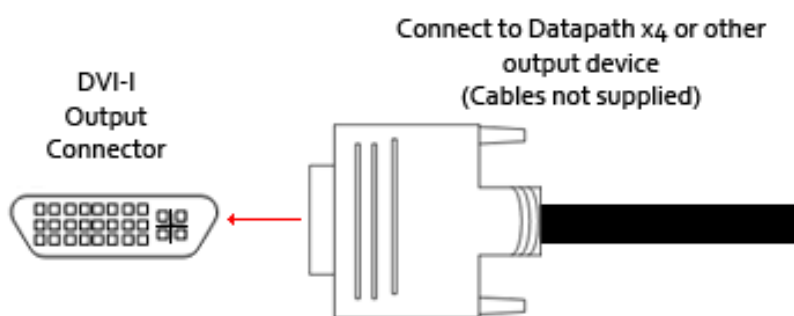

Fig.4

USB Socket

The USB socket on the rear of the unit is used to connect the dL8 to a PC via a USB connection using the supplied USB Type A to Type B cable. Configuration of the dL8 is programmable via an application utility allowing the easy configuration of your display wall.

Step 4

Operation Indicators

The front panel has three LEDs to indicate the operational status of the dL8:

- Power
- Input
- Status

Power

When illuminated, the Power LED indicates the dL8 is connected to a mains supply and the power switch is on.

Input

When illuminated, the Input LED indicates a valid DVI source is connected.

Status

- Continuous illumination – Indicates the dL8 is operating normally.
- Flashing – Unit is operating over the normal operating temperature. Ensure the input fan vent is not blocked.

When the dL8 device is connected to a PC by a USB cable, and the dL8 control application is active, then all three lights flash in turn to help to identify which unit is being controlled.

EDID SETUP

The EDID SETUP button is used to populate the onboard EDID of the dL8 from the EDID on the device connected to Output 1. When pressed, the three LEDs will flash in sequence to indicate that the operation was successful.

If the LEDs do not flash, this indicates that the operation to copy the EDID did not work. This could be because of either Output 1 does not have a device with an EDID or the EDID is corrupt and could not be read.

Note: To avoid the accidental operation of the EDID SETUP, the button must be pressed for a minimum of 3 seconds. The function will then be unavailable for a period of 10 seconds.

Step 5

Configuring the dL8

Installing the dL8 Driver and Software Application

Note: Do not plug the dL8 into a USB port until the driver installation is complete.

Locate the Install folder on the Datapath CD supplied with the dL8, run *install.exe*. and follow the installation wizard. During installation a warning message may be displayed stating that the driver does not have Windows® Logo accreditation.

Select Continue Anyway to complete the installation.

The Datapath dL8 can now be connected to a suitable USB 2.0 port using the cable supplied. At this point the hardware will be detected by Windows® as a dL8, and a New Hardware wizard is displayed. Allow the wizard to search, and click on the recommended option to enable the previously installed driver to be associated with the new hardware.

Press *Continue Anyway* to accept the driver.

We suggest that you regularly visit the Datapath web site (www.datapath.co.uk) for information on updated drivers.

Running the dL8 Application

To open the dL8 application select *Start/All Programs/Datapath dL8*.

The application will search for a dL8 connected to your computer and display the status of the current input.

Once the application has detected an dL8 the main status screen is displayed Fig.5

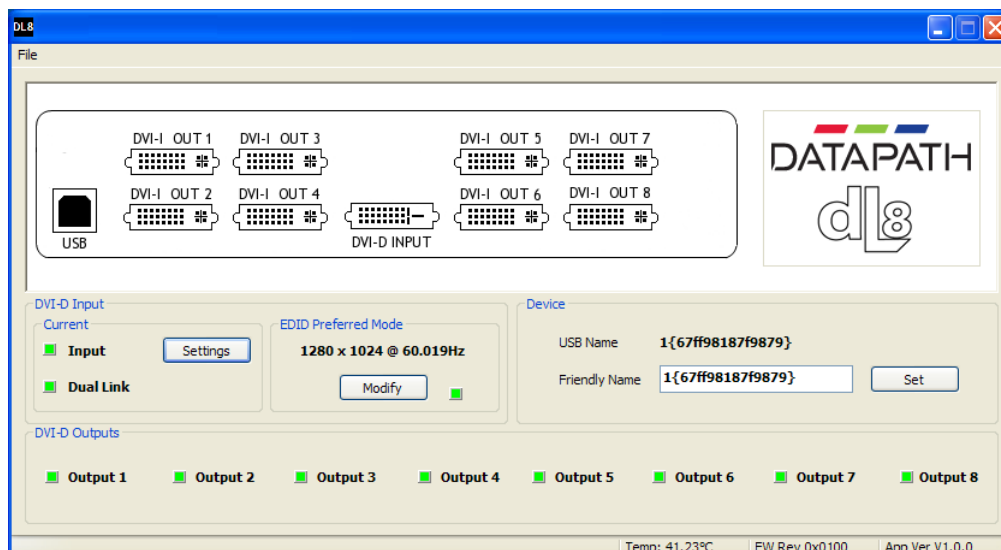

Fig.5

The main control dialog is divided into the following groups:

Connection

DVI-D Input

EDID Preferred Mode

DVI-I Outputs

Connection Diagram

The connection diagram displays a schematic view of the rear panel of the dL8 to assist in identifying the connectors.

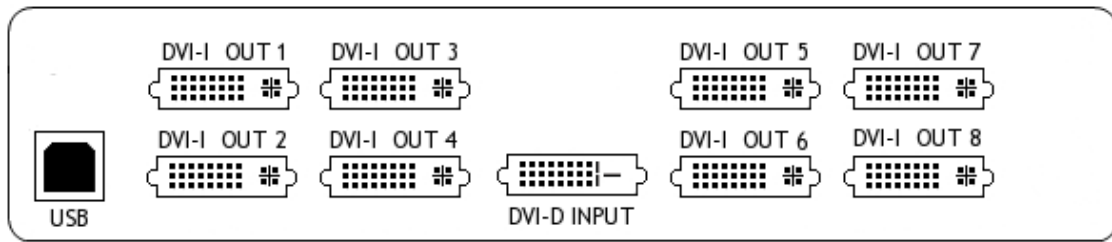

Fig. 6

Device

The unique USB device name that is connected is displayed in the Device group. It is possible to associate a more user friendly name such as "Main Video Wall". The friendly name is stored in non-volatile storage on the dL8 and can help identify the device during future configurations. Specific devices connected to your PC can be selected using the **Select Device..** command on the File Menu. The dL8's will be listed by the USB Device or by a previously configured friendly name.

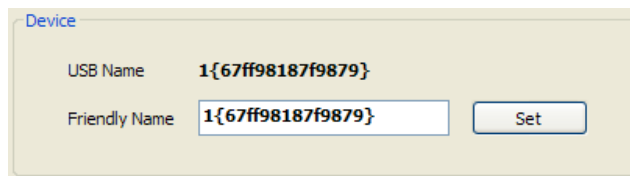

Fig. 7

DVI-D Input

The DVI-D Input group indicates if an input is currently being captured and if the input is Dual Link. It also displays the preferred mode that has been programmed into the dL8's EDID. Use the Modify button to update the EDID. The small square to the left of Input and Dual Link indicates:

- Green – A valid input is connected to the dL8. The input connected is Dual Link
- Grey – A valid input is not connected. Dual Link input not detected.

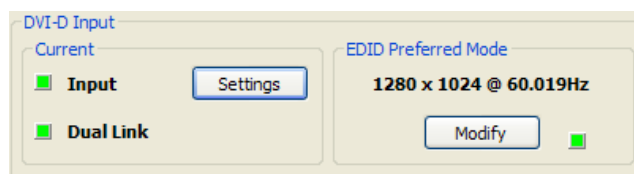

Fig.8

To boost the equalization hardware click on the Settings button and the following dialog is displayed. Fig 9.

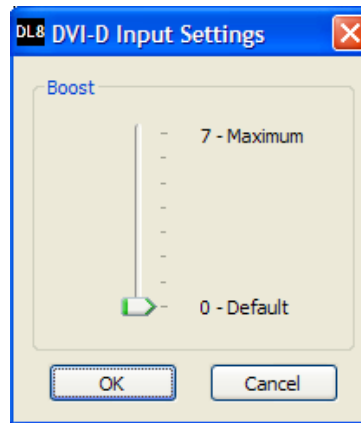

Fig. 9

Use the slider to compensate for the loss signal quality due to DVI cable lengths over 5 m. The equalization hardware can compensate for cables up to 20m in length.

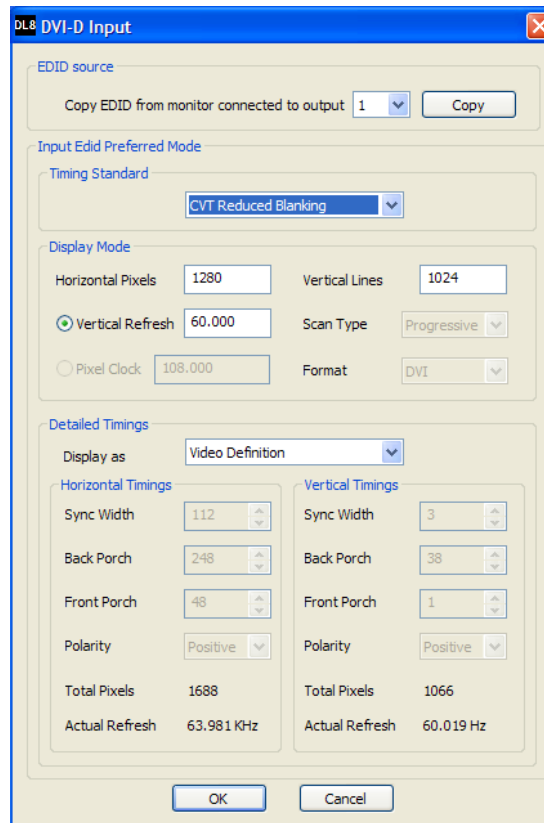

Fig. 10

The DVI-D Input dialog Fig.10 allows you to copy the EDID from devices connected to the outputs. This function is used if all the connected outputs are identical.

If the LEDs do not flash, this indicates that the operation to copy the EDID did not work. This could be because of either the selected Output does not have a device with an EDID or the EDID is corrupt and could not be read. To copy the EDID timings click on the Copy button. Alternatively, the EDID can be set manually.

The dialog supports standard timing formula such as:

- VESA CVT
- VESA CVT Reduced Blanking
- SMPTE (for HD modes)
- VESA GTF
- Custom

Selecting Auto from the drop down list will typically default to the VESA CVT algorithm which best matches typical standard VESA output modes. However, to minimise dot clocks and hence maximise DVI cable lengths, the CVT Reduced Blanking formula is recommended.

Selecting Custom allows the timing parameters to be edited. It should be noted that you will need to select between definition of Pixel Clock or Vertical Refresh since these are mutually exclusive parameters.

Once edited, clicking OK writes the preferred mode into the EDID but will not normally affect the input mode that is being captured. It may be necessary to force the graphics device in the host machine to detect the new modes, this can be done by selecting **Detect** on the Screen Resolutions dialog box (Windows® 7) or by disconnecting the source from the dL8 and reconnecting.

All modifications to the Input settings can be saved as part of a .dda file, removing the requirement to input the same settings again. To save the settings select the Save... command in the File menu. To open a saved .dda file select the Open... command.

Specification

Physical Dimensions	19"-Rack mount (1U) (438mm x 40mm x 172 mm)
Input Connectors	DVI-D (Dual Link) USB (Type B) for host communications IEC mains power inlet
Output Connectors	8 x DVI-D (Dual Link)
Front panel Controls	Push button for EDID sampling Three LED indicator lamps (Power/Input/Status) and flashing feedback for USB communications or EDID button press.
Input Capabilities	Incorporates TMDS re-clocking equalizer to support up to 20m cables ⁽¹⁾ Programmable EDID to indicate preferred mode No limit to aspect ratios or frame rates of DVI signals that can be accepted, provided they remain within the Dual-Link 330MHz specification Input is not HDCP compatible.
Output Capabilities	Supports up to 5m cables into standard DVI receiver ⁽²⁾
USB Connection	Supports USB 2.0 for programming of input EDID parameters using Datapath dL8 Control application Operating system support: Windows XP, Windows Server 2003, Windows Vista, Windows Server 2008, Windows 7
Power Requirements	Universal power supply (100-240V). 25W maximum ⁽¹⁾
Operating Temperature	0 to 35 °C (32 to 96°F) Internal Fan cooling
Storage Temperature	-20 to 70 °C (-4 to 158°F)
Relative Humidity	5% to 90% non-condensing
Warranty	3 years

Notes:

(1) Provisional specification

(2) Output cable lengths can be extended when driving receivers with built in equalization – up to 20m for Datapath X4.

UK Headquarters and Main Sales Office
Datapath Ltd.,
Alfreton Road,
Derby, DE21 4AD, UK
Tel: +44 (0) 1332 294441
Email: sales@datapath.co.uk
www.datapath.co.uk